

Concept Tiles

Micro Cement Ceramic
Micro Cemento Cerámico

COLOR BODY PORCELAIN
PORCELÁNICO MASA COLOREADA

**CONTEMPORARY
MIXTURES
SURFACES I**

Cement

Micro Cement Collection has a sober style and can create minimalist environments. Inspired by the typical microcement polishing and smooth to touch, this collection combines a simple and elegant design with high functionality and measures up to 90x90 and 60x180 cm. The unevenness of natural stone, of the salts, and the watery effects turn into decorative resources, while the very nature of ceramics prevents problems derived from water absorption and efflorescences. Its color choice is a perfect combination of timelessness and trendy colors, which widens the combination capabilities of Contemporary Mixtures Surfaces.

Scale **1:2**
Escala **1:2**



Micro Cement Light

Micro Cement Grey

Micro Cement Taupe

Micro Cement Anthracite



Project Clothing Shop.

In this sober looking fashion boutique, the choice of materials is fundamental for creating the ambiance. The walls have been covered with Micro Cement Light, inspired by polished microcement, and in the pieces of which we can appreciate the perfect decorative finishing of the ceramics. For the flooring, the designer has opted for a vanilla-colored ceramic oak wood that emphasizes the contrast with the walls between organic and artificial.

Mixed Surfaces in Shop Entrance:
Combinación de Superficies en Entrada a Tienda:

E 1/5

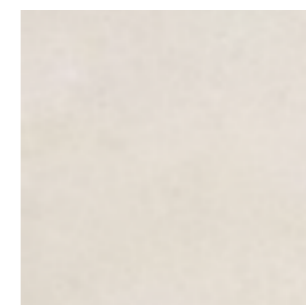

Micro Cement Light (Wall)
60x180 (24" x 72")



Micro Cement Light

This detail shows the polished ceramic microcement. It is a state-of-the-art material that perfectly avoids the disadvantages of porous materials, but replicating their decorative effects. These are materials that conform to the technical requirements of public spaces without sacrificing beauty.

Applied Surface in Shoes Area:
Superficie Aplicada en Zona Zapatería:

E 1/5

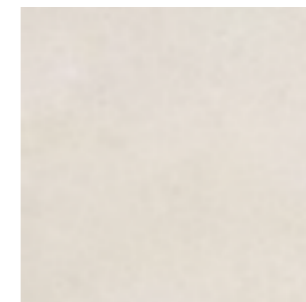

Micro Cement
Light (Floor) 90x
90 (36" x 36")

Project Private Residence.

Not just for its particular organization, but also for its simple interior design, this house is thought to be lived and to adapt itself to the different uses through large and flexible spaces. The choice of materials is contemplated as an exercise of combination of state-of-the-art materials. Which actually work, creating a space full of modernity that takes industrial references in order to introduce them into a domestic space.

Mixed Surfaces in Dining Room & Kitchen:

E 1/5

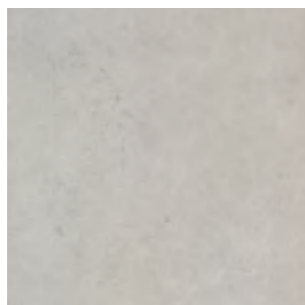

Micro Cement Grey (Floor)
90x90 (36" x 36")



Concept Tiles

Micro Cement Grey

In the living room the traditional qualities of ceramics can be perceived through a flawless large format white paste product, together with the application of latest technologies, which are capable of generating a trendy product such as Micro Cement Grey, a ceramic microcement in a timeless light grey shade that has great personality.

Applied Surface in Reading's Corner:

E 1/5

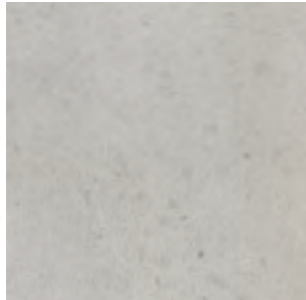

Micro Cement Grey (Floor) 90x90 (36" x 36")



Concept Tiles



Micro cement|Taupe

Project Bathroom Restoration:

In recent years the bathroom concept has changed considerably, going from being a simple functional room to being a place designed for relaxing. This project has gained square meters for the bathroom, creating a large space. A mole grey ceramic microcement that gives continuity in the space reserved for the shower, is used on the wall coverings. The material is available in two formats: 30x180, and in mosaic format..

Mixed Surfaces in Bathroom Entrance:

E 1/5

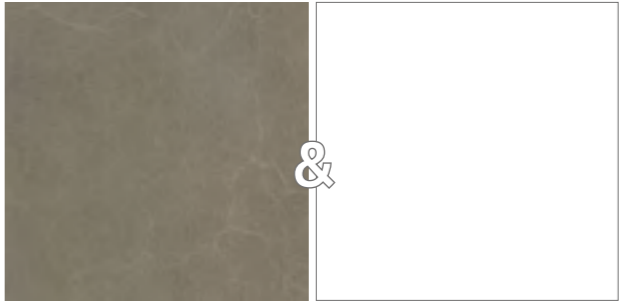

Micro Cementi **Taupe** (Floor)
30x180 (12" x 72")
Mureto : 30x30 (12" x 12")

White&Glass **White** (Wall)
40x120 (16" x 48")

Micro Cement Taupe

In the bathtub area we can see clearly the pieces in the Micro Cement Taupe line. The details of this ceramic microcement reveal the watery effects and efflorescences of microcement, adding the exceptional technical performance of ceramics. Thus, it is possible to bring cementitious materials to wet rooms such as the bathroom.

Applied Surface in Bathroom Detail:

E 1/5



Micro Cement
Taupe (Floor) 30x
180 (12" x 72")





Micro Cement Anthracite

Project Junior Suite Hotel.

Once again ceramics is revealed as a multi-functional material with great decorative opportunities. The blend of natural oak on the walls, with the cement-looking Micro Cement Anthracite line on floors and the headboard, generates a combination of materials with endless possibilities. Here ceramics is revealed as a material with great versatility in its coexistence with all kinds of surfaces.

E 1/5

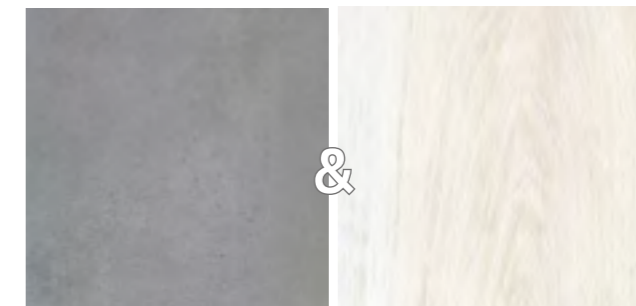

Micro Cement Anthracite (Floor) 90x90 (36" x 36")
Lightwood White (Wall) 20x120 (8" x 48")

Micro Cement Anthracite

In this hotel's suite bathroom we have sought to create a neutral and avant-garde ambiance through the use of ceramic microcement. On this occasion, we have played with the dimensions of the pieces: a large format, 90x90, and small pieces, 3x15, installed horizontally. The result is a modern space which invites one to relax.

Applied Surface in Bathroom Detail:

E 1/5

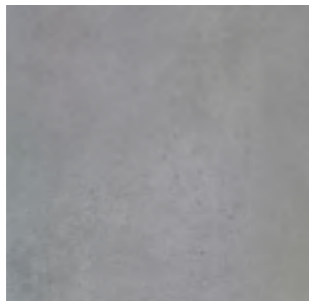

Micro Cement Anthracite (
Wall)
90x90 (36" x 36")
Mosaic 330 : 3x30 (1,5" x 12")



TECHNICAL INFORMATION



SPECIAL PIECES



ENVIRONMENT & SUSTAINABILITY



ENVIRONMENT & SUSTAINABILITY



Micro Cement Ceramic



N° DESIGNS BY FORMAT / 60x180: **13** / 30x180: **26** / 90x90: **16** / 45x90: **32**
60x60: **28** / 30x60: **56** / 10x60: **168**

COLOR BODY PORCELAIN / THICKNESS: 11 mm / RECTIFIED / DESTONIFIED V.2

Formats & Sizes

Scale 1/20

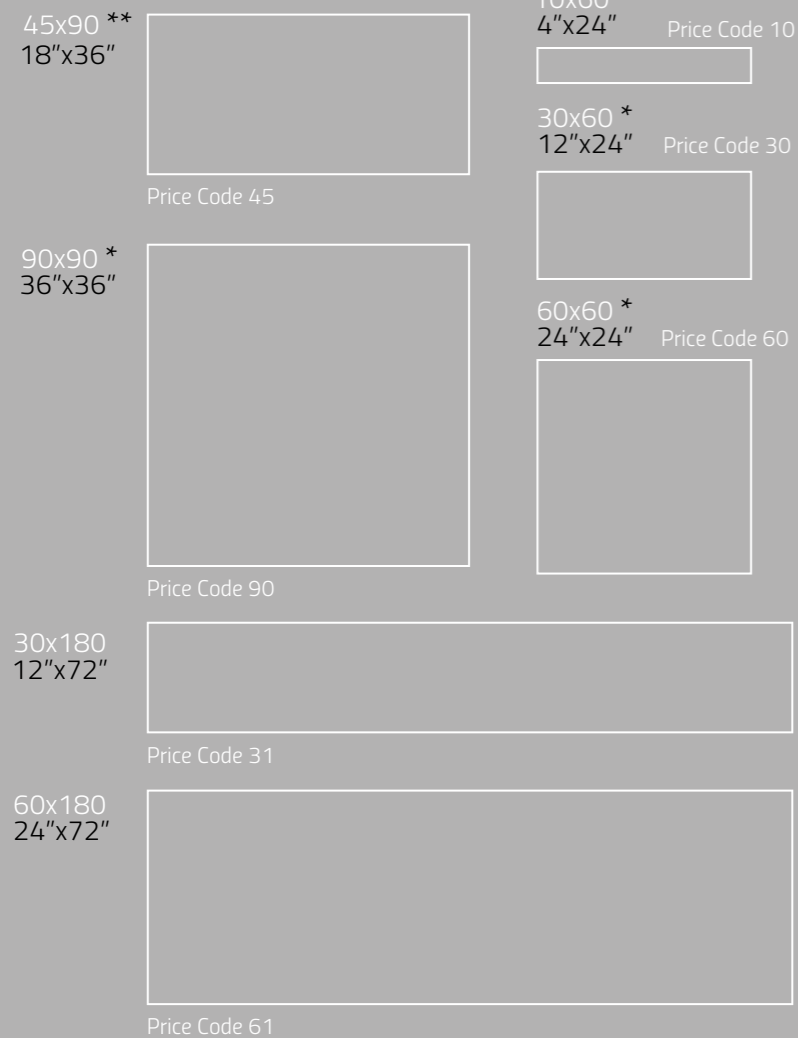

* R10 Antislip Available /

** SERVICE Antislip On Demand /

Complements

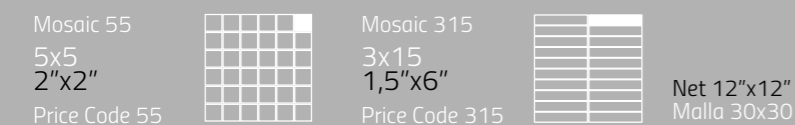

Scale 1/20



· Micro Cement **Light** 30x180 (12"x72")

Special Pieces

Scale 1/20

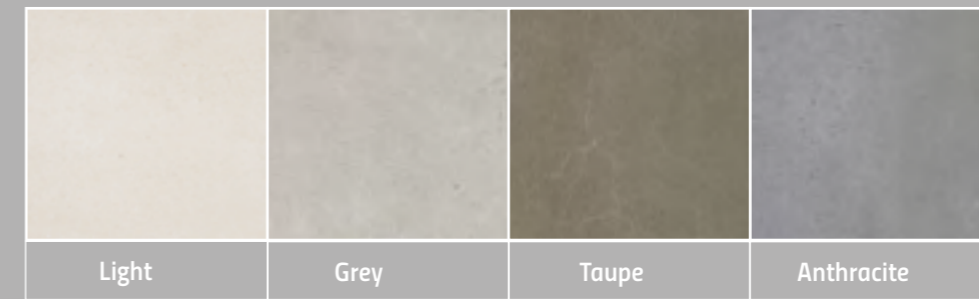
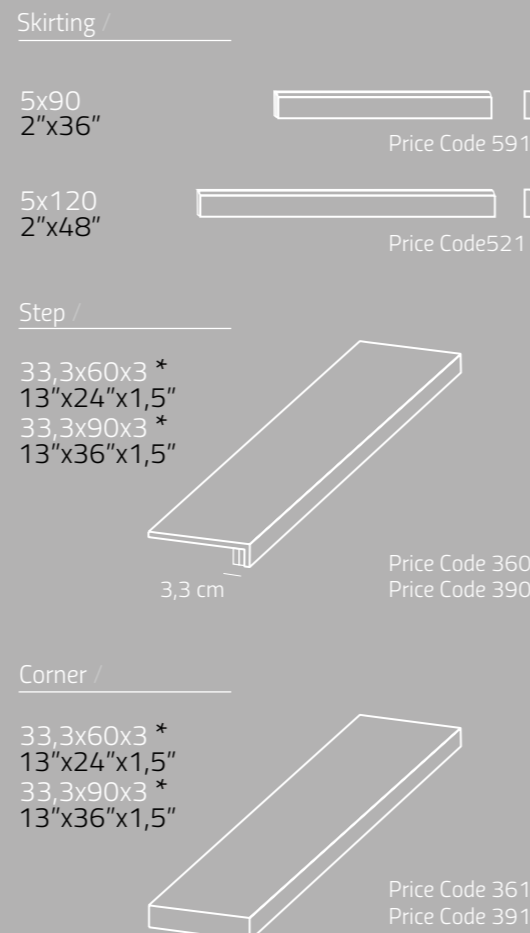

Standards	Features	Required Value	
ISO 10545 / 2	Dimensions and surface quality Water absorption /	Required /	Guaranteed /
ISO 10545 / 3	Breaking strength /	Grupo B1 A / E < 0,5 %	E ≤ 0,5 %
ISO 10545 / 4	Bendind strength /	> 1300 N	≥ 1300 N
ISO 10545 / 5	Resistance to deep abrasion /	> 35 N/mm ²	> 35 N/mm ²
ISO 10545 / 6	expansion /	≤ 175 mm ³	Guaranteed /
ISO 10545 / 8			7X10 ⁻⁶ / c°
ISO 10545 / 9	Thermal shock resistance / Frost resistance /	Required /	Guaranteed /
ISO 10545 / 12	Chemical resistance /	Required /	Guaranteed /
ISO 10545 / 13	Stain resistance /	Min. GB / GLB	Guaranteed /
ISO 10545 / 14	Coefficient of friction /	Min. Clase 3	Guaranteed / R9 / R10 *
DIN 51130	Pendulum Test /	Min. R9	
UNE ENV 12633	Reaction to fire /	Min. Clase 1	Clase 1 / Clase 2
UNE EN 13501-1:2002			A1 / A1FL
V O C	Not release volatile elements /		

Green Standards

Green Building Member



Environmental Management System ISO 14001

Packing & Price Code

Nominal	Real	Price Code	Pieces / Box	M ₂ / Box	Kg / Box	Boxes / Pallet	M ₂ / Pallet	Kg / Pallet
10x60	9,8x59,8	10	12	0,70	18,00	70	49,00	1280
30x60	29,8x59,8	30	6	1,07	25,60	40	42,80	1044
60x60	59,8x59,8	60	3	1,07	28,00	32	34,24	916
45x90	44,8x89,8	45	3	1,20	30,90	28	33,60	885
90x90	89,8x89,8	90	2	1,61	41,00	20	32,20	885
30x180	29,8x179,8	31	3	1,07	26,08	36	33,60	840
60x180	59,8x179,8	61	1	1,07	26,08	36	38,52	985
5x90	5x89,8	591	5	4,5 ML	5,00			
5x120	5x119,8	521	5	6,0 ML	8,50			
33,3x60x3	33,3x59,8x3	360	2	1,6 ML	7,00			
33,3x90x3	33,3x89,8x3	390	2	1,8 ML	10,00			
33,3x60x3	33,3x59,8x3	361	1	0,6 ML	7,30			
33,3x90x3	33,3x89,8x3	391	1	0,9 ML	10,50			
5x5	Mosaic 55	55	3	0,80	12,00			
3x15	Mosaic 315	315	5	0,45	11,00			
Mureto	Mureto Mosaic	300	5	0,45	11,00			